

GARAY

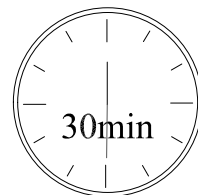

| | L | W | H | Pcs |
|----------|-----|-----|----|-----|
| 1 | 169 | 135 | 54 | 1x |
| 2 | 220 | 118 | 54 | 1x |

R

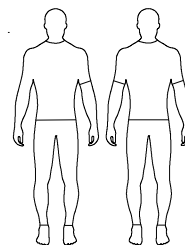
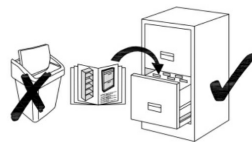
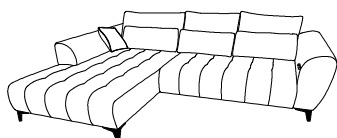
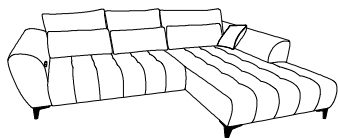
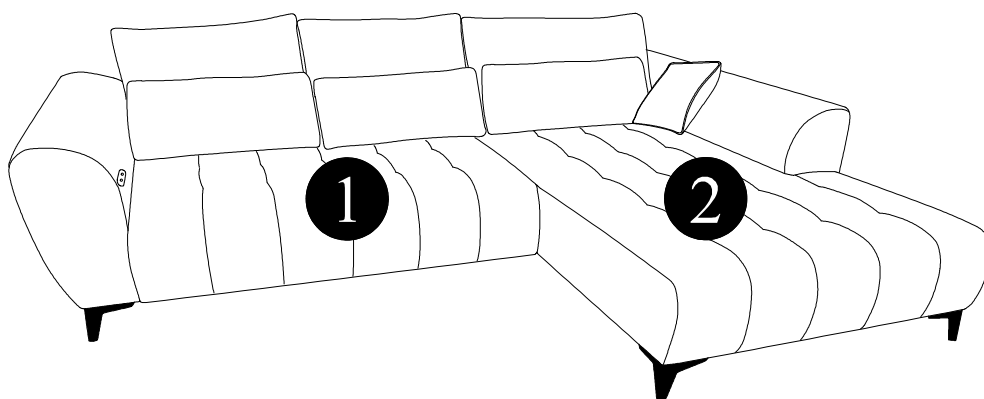

L

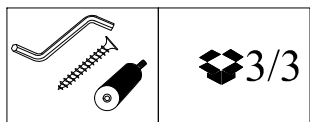
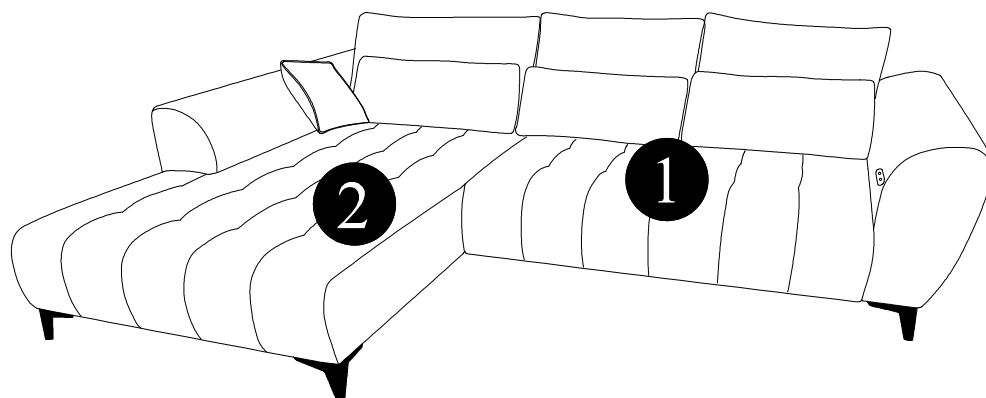

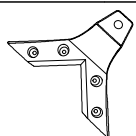
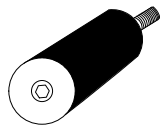
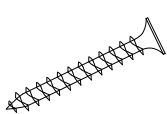
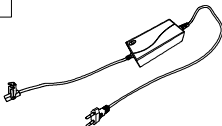
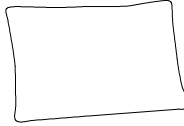
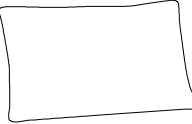
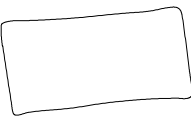
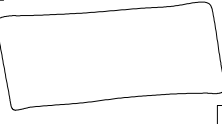
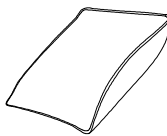
| | | | | |
|--|---|---|---|---|
| <p>A</p>  <p>H-120 4x</p> | <p>B</p>  <p>H-120 8x</p> | <p>C</p>  <p>3,5x35 16x</p> | <p>D</p>  <p>1x</p> | <p>E</p>  <p>2x</p> |
| <p>F</p>  <p>1x</p> | <p>G</p>  <p>2x</p> | <p>H</p>  <p>1x</p> | <p>I</p>  <p>1x</p> | |

| | | | |
|-------|-------|--------|----|
| A | B | C | D |
| H-120 | H-120 | 3,5x35 | |
| 2x | 3x | 8x | 1x |

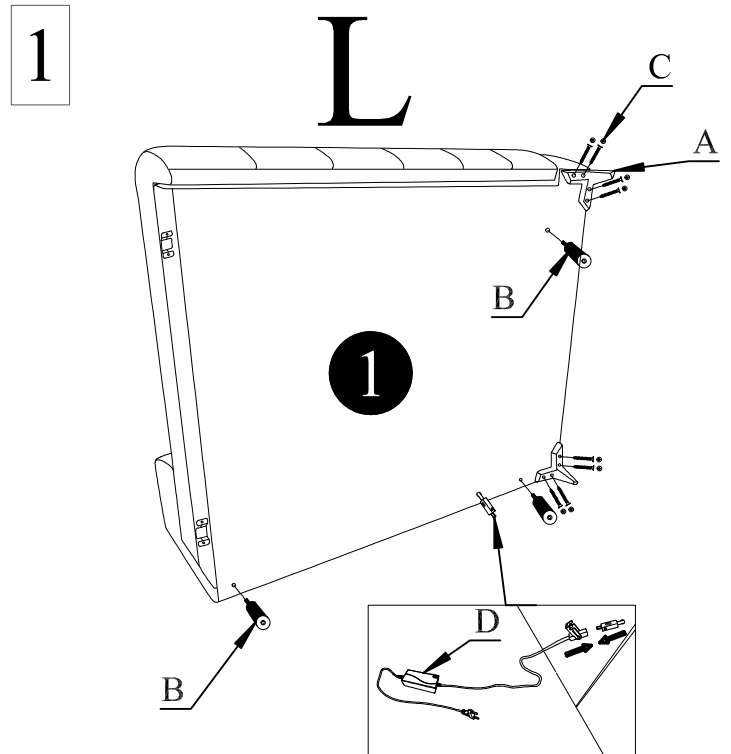
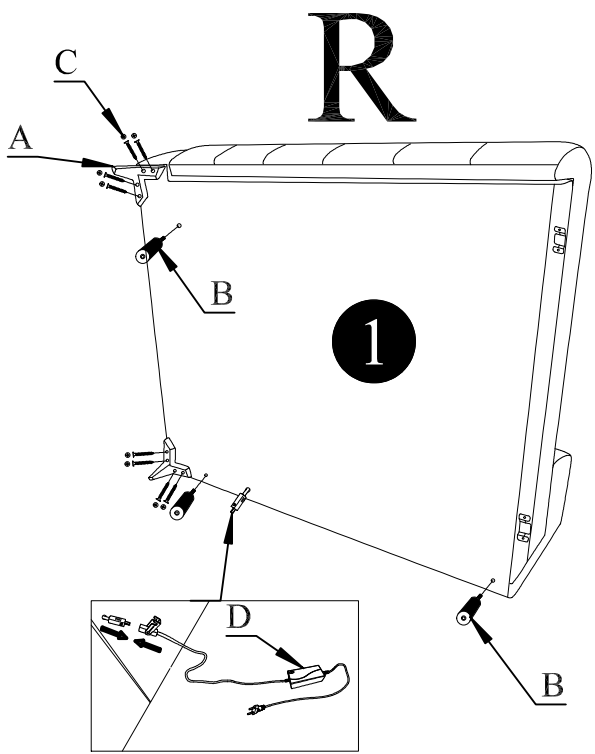

| | | |
|-------|-------|--------|
| A | B | C |
| H-120 | H-120 | 3,5x35 |
| 2x | 5x | 8x |

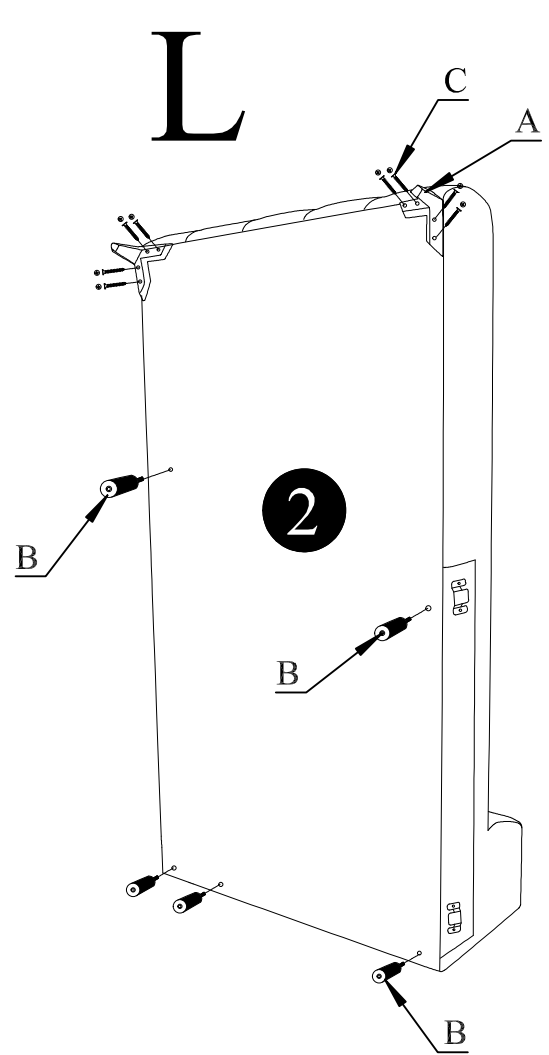
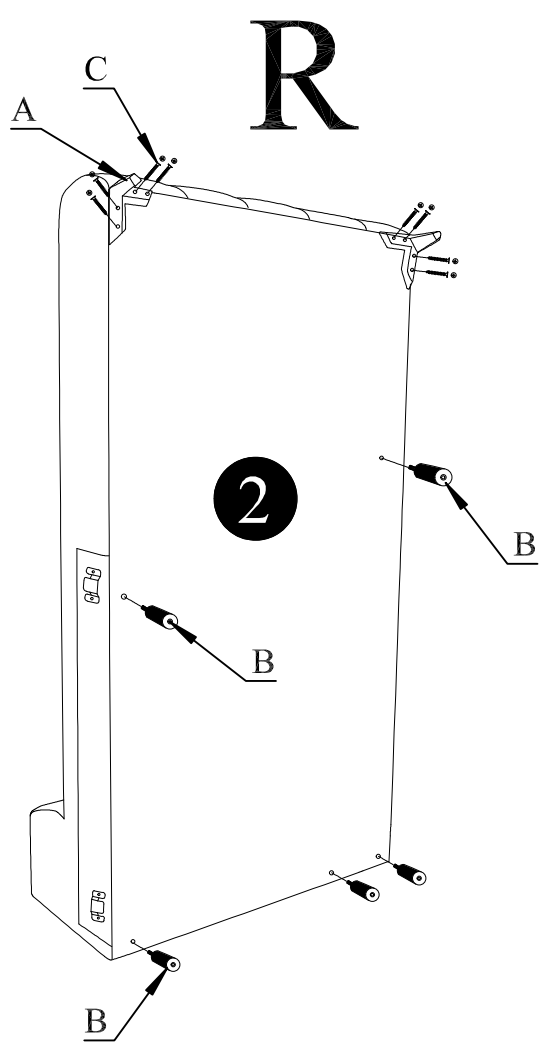

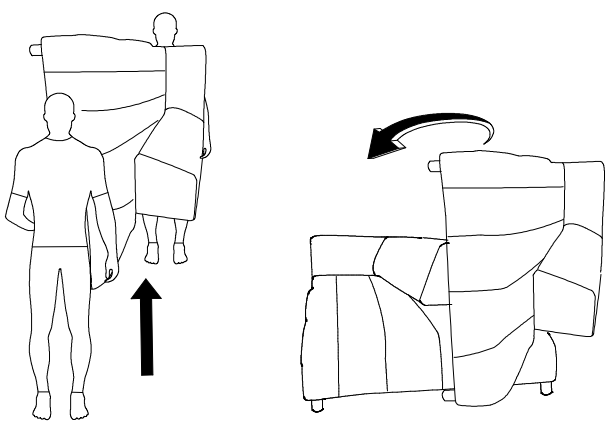

3

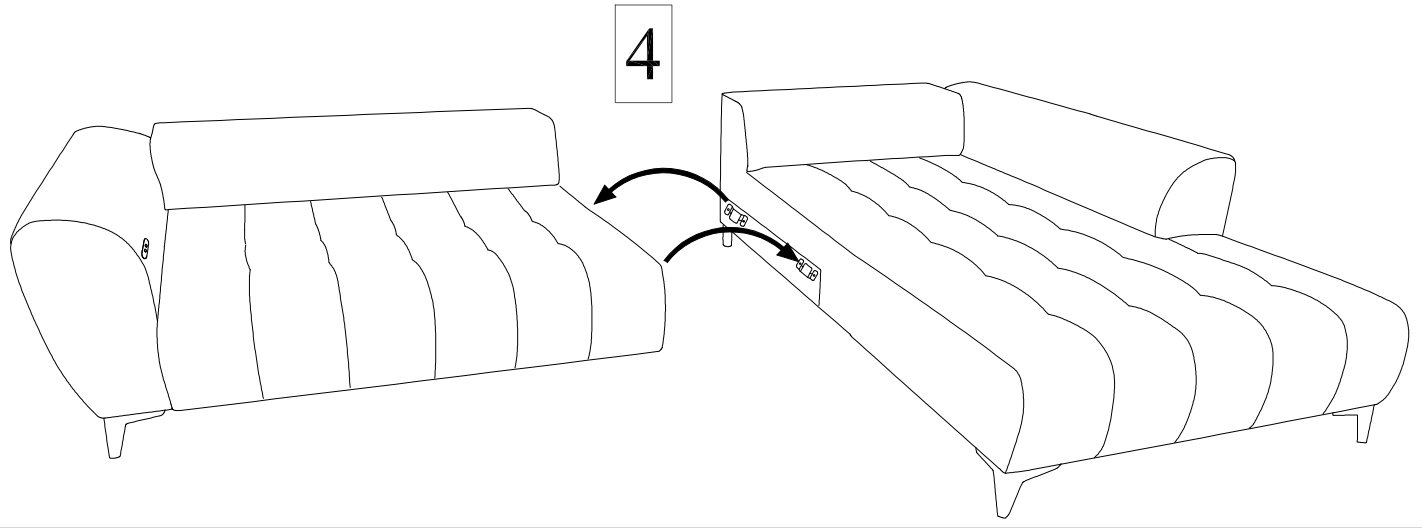
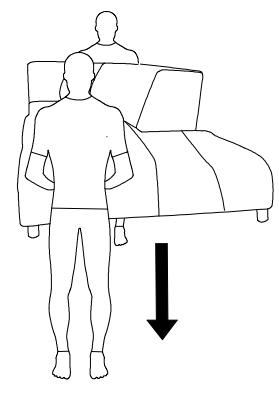

4

